

15 designs offert en 13 couleurs. [Voir plus de détails sur la construction.](#)

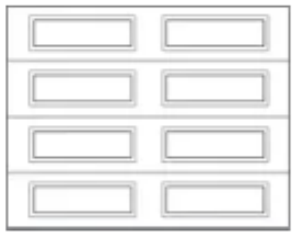

Prestige XL

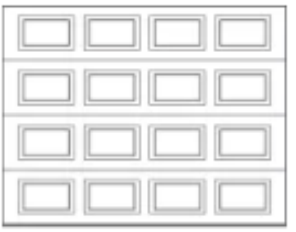

Classique CC

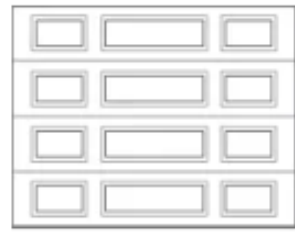

Classique MIX

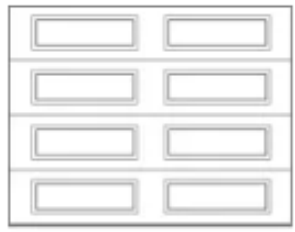

Classique XL

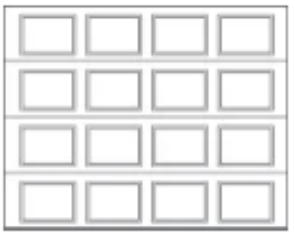

Shaker-Plat CC

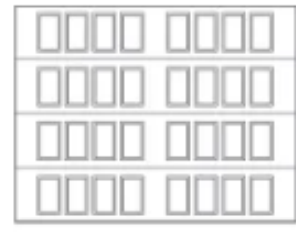

Shaker-Plat XS



Shaker-Plat XL

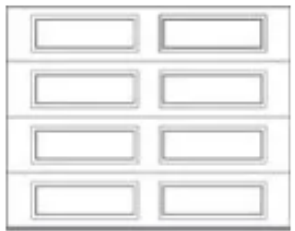

Shaker-Moderne XL

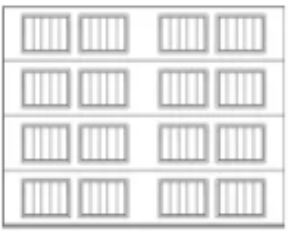

North Hatley SP



North Hatley LP



Vog®

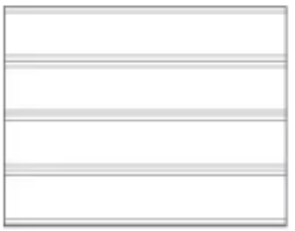

Moderno 2 lignes

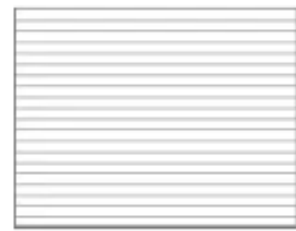

Moderno multi

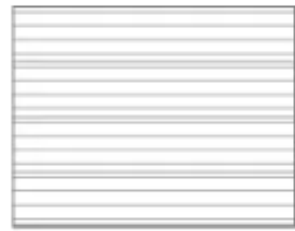

Rainuré

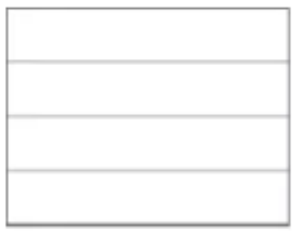

Uni



MODÈLES GARAGA / PORTES STANDARD+

Construction de la porte de garage Standard+ R-16

Principales caractéristiques

CARACTÉRISTIQUES

- Facteur d'isolation R-16 ?
- Épaisseur de 1 ¾"
- Isolation au polyuréthane
- Acier galvanisé au fini grain de bois léger
- Ferronnerie Dura+ ?

Couleurs solides

Standard



Blanc glacier



Sable



Argile



Sablon



Brun commercial

Premium



Charbon



Vert conifère



Noir



Minerai de fer

Faux bois



Noyer chocolaté,
Faux bois



Noyer américain,
Faux bois

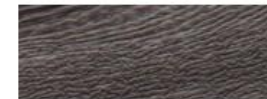

Gris patiné, Faux bois



Noyer foncé, Faux
bois

GRANDEURS

- Largeur à chaque pouce de 8' à 18'.
- Hauteur aux 3 pouces de 6'6" à 8'.

Autres grandeurs disponibles sur demande. [Contactez-nous](#) pour en savoir plus.



MODÈLES GARAGA / PORTES STANDARD+

Voici les modèles de fenêtres disponibles dans notre catégorie Types de verre :

- Zen noyer sablé
- Pure
- Soft
- Fluid
- Azur
- Masterline
- Chinchilla
- Screen
- Pinhead
- Sablé blanc / Satiné
- Sablé gris
- Satiné noir
- Givré
- Teinté
- Clair

VERRES GARAGA

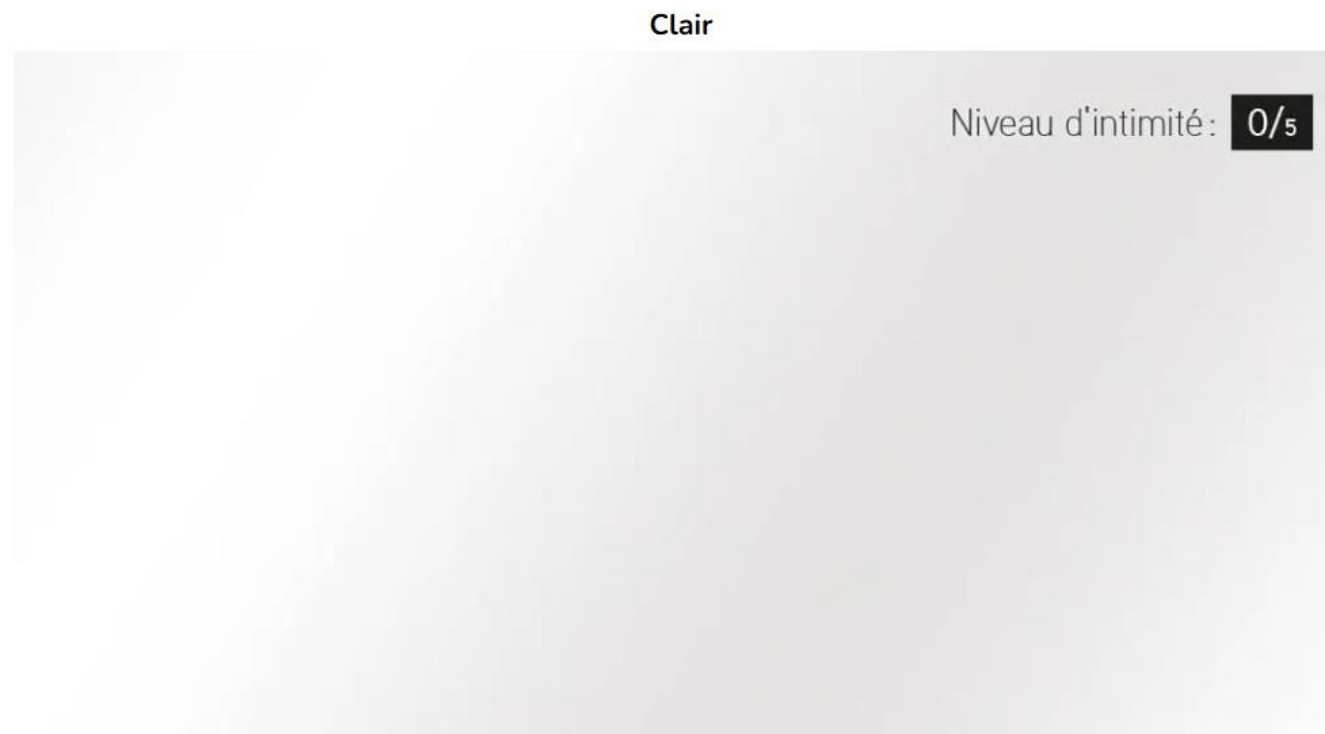

Format disponible : 20" x 13", 21" x 13", 40" x 13", 41" x 16" ou pour fenêtres Panoramique.

Sablé blanc / Satiné

Niveau d'intimité: **4/5**

Format disponible : Sablé blanc : 21" x 13" et 40" x 13" ou pour fenêtres Panoramique. Satiné : 20" x 13" et 41" x 16"

Le verre Sablé blanc / Satiné permet de gagner en intimité sans vous privé de la lumière extérieur. Ce verre permet de cacher la vue vers l'intérieur comme vers l'extérieur.

En savoir plus sur le [verre Sablé blanc](#).

VERRES GARAGA

Sablé gris

 Save

Niveau d'intimité: **4/5**

Format disponible : 40" x 13"

Le verre Sablé gris est parfait pour ajouter une touche tendance à votre porte de garage. Il vous permet de conserver votre intimité sans vous priver de la lumière extérieure.

En savoir plus sur le [verre Sablé gris](#).



Teinté

Save

Niveau d'intimité: 1/5

Format disponible : 20" x 13", 21" x 13", 40" x 13", 41" x 16" et 40" x 7"

Le verre Teinté est un bon choix si on veut laisser entrer la lumière à l'intérieur du garage. Avec sa belle teinte grise, il permet d'avoir une légère intimité.

VERRES GARAGA

Givré

Niveau d'intimité: 3/5

Format disponible : 21" x 13" ou 40" x 13"

Le verre givré, parfois appelé « dépoli », est un verre classique qui a été traité au sable ou à l'acide pour créer un effet de surface satinée. Ainsi, même s'il reste translucide, ce verre permet de cacher légèrement la vue vers l'intérieur comme l'extérieur.

QUANTUM



Couleur : **BLANC**

En ACIER - FINI LISSE
Prix \$\$\$\$

[Explorez](#) [Créez votre porte](#)



GRAIN DE BOIS



Couleur : **Blanc**

Le style minimaliste R16
Prix \$\$\$\$

[Explorez](#) [Créez votre porte](#)



GRAIN DE BOIS 138



Couleur : **BLANC**

MINIMALISTE
Prix \$\$\$\$

[Explorez](#) [Créez votre porte](#)



SHAKER XL



Couleur : **Blanc**

Look moderne
Prix \$\$\$\$

[Explorez](#) [Créez votre porte](#)



SHAKER



Couleur : **Blanc**

Look moderne
Prix \$\$\$\$

[Explorez](#) [Créez votre porte](#)



NEW HAMPSHIRE XL



Couleur : **Blanc**

Look champêtre moderne
Prix \$\$\$\$

[Explorez](#) [Créez votre porte](#)



GARÉX

URBAINE



Couleur : **Blanc**

ÉPURÉE
Prix \$\$\$\$

[Explorez](#) [Créez votre porte](#)



URBAINE 138



Couleur : **BLANC**

ÉPURÉE
Prix \$\$\$\$

[Explorez](#) [Créez votre porte](#)



URBAINE MR



Couleur : **Blanc**

TENDANCE
Prix \$\$\$\$

[Explorez](#) [Créez votre porte](#)



URBAINE MR 138



Couleur : **BLANC**

TENDANCE
Prix \$\$\$\$

[Explorez](#) [Créez votre porte](#)



RAINURÉ



Couleur : **Blanc**

CONTEMPORAIN
Prix \$\$\$\$

[Explorez](#) [Créez votre porte](#)



MULTI-GROOVE



Couleur : **Blanc**

CONTEMPORAIN
Prix \$\$\$\$

[Explorez](#) [Créez votre porte](#)



RAINURÉ 138

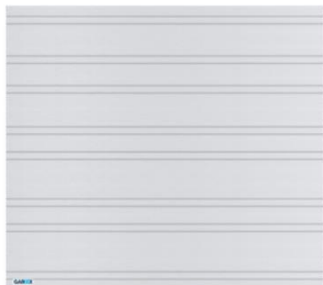

Couleur : **BLANC**

CONTEMPORAIN
Prix \$\$\$\$\$

[👁 Explorez](#) [✍ Créez votre porte](#)



CLASSIQUE



Couleur : **Blanc**

CLASSIQUE
Prix \$\$\$\$\$

[👁 Explorez](#) [✍ Créez votre porte](#)



CLASSIQUE 138



Couleur : **BLANC**

CLASSIQUE
Prix \$\$\$\$\$

[👁 Explorez](#) [✍ Créez votre porte](#)



PREMIUM

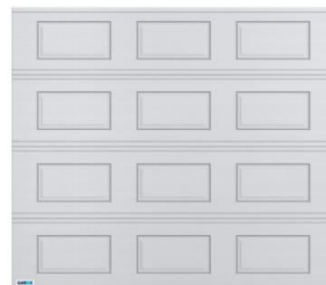

Couleur : **Blanc**

CLASSIQUE
Prix \$\$\$\$\$

[👁 Explorez](#) [✍ Créez votre porte](#)



PREMIUM SÉLECT XL

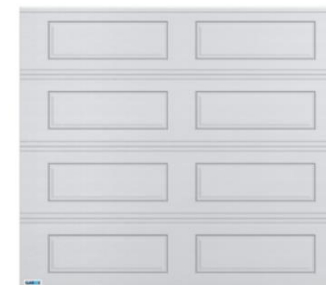

Couleur : **Blanc**

RAFFINÉE
Prix \$\$\$\$\$

[👁 Explorez](#) [✍ Créez votre porte](#)



PREMIUM SÉLECT MX-B



Couleur : **Blanc**

BEAUTÉ - GAUCHE
Prix \$\$\$\$\$

[👁 Explorez](#) [✍ Créez votre porte](#)



PREMIUM SÉLECT MX-R

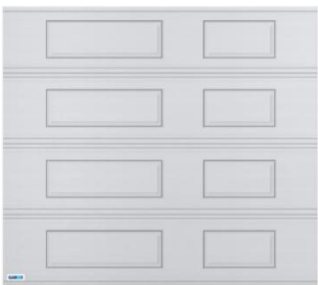

Couleur : **Blanc**

BEAUTÉ
Prix \$\$\$\$\$

[👁 Explorez](#) [✍ Créez votre porte](#)



PREMIUM SÉLECT MX



Couleur : **Blanc**

BEAUTÉ
Prix \$\$\$\$\$

[👁 Explorez](#) [✍ Créez votre porte](#)



SEIGNEURIE HERITAGE



Couleur : **Blanc**

DISTINCT
Prix \$\$\$\$\$

[👁 Explorez](#) [✍ Créez votre porte](#)



VERMONT

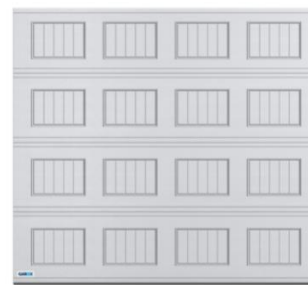

Couleur : **Blanc**

UNIQUE
Prix \$\$\$\$\$

[👁 Explorez](#) [✍ Créez votre porte](#)



VERMONT 138



Couleur : **BLANC**

UNIQUE
Prix \$\$\$\$\$

[👁 Explorez](#) [✍ Créez votre porte](#)



NEW HAMPSHIRE

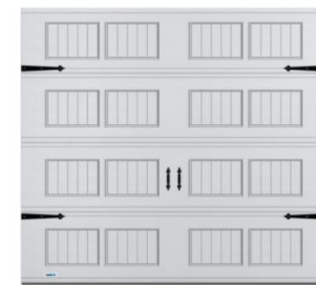

Couleur : **Blanc**

PRESTIGE
Prix \$\$\$\$\$

[👁 Explorez](#) [✍ Créez votre porte](#)



NEW HAMPSHIRE 138



Couleur : **BLANC**

PRESTIGE
Prix \$\$\$\$\$

[Explorez](#) [Créez votre porte](#)



PORT ROYAL



Couleur : **Blanc**

AUTHENTIQUE
Prix \$\$\$\$\$

[Explorez](#) [Créez votre porte](#)



TILLY



Couleur : **Blanc**

AUTHENTIQUE
Prix \$\$\$\$\$

[Explorez](#) [Créez votre porte](#)



MONTARVILLE

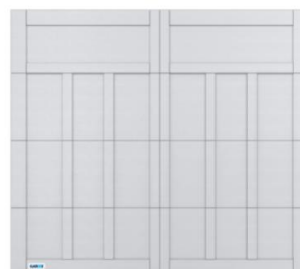

Couleur : **Blanc**

AUTHENTIQUE
Prix \$\$\$\$\$

[Explorez](#) [Créez votre porte](#)



VILLERAY ÉTENDUE

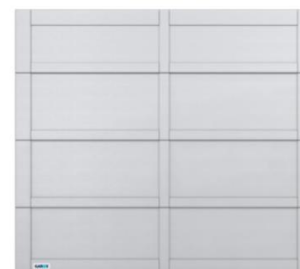

Couleur : **Blanc**

AUTHENTIQUE ÉTENDUE
Prix \$\$\$\$\$

[Explorez](#) [Créez votre porte](#)



VILLERAY UNIFORME

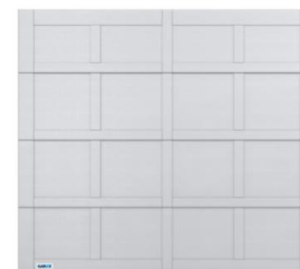

Couleur : **Blanc**

AUTHENTIQUE UNIFORME
Prix \$\$\$\$\$

[Explorez](#) [Créez votre porte](#)



VILLERAY COMPACTE



Couleur : **Blanc**

AUTHENTIQUE COMPACTE
Prix \$\$\$\$\$

[Explorez](#) [Créez votre porte](#)



MITIS



Couleur : **Blanc**

AUTHENTIQUE
Prix \$\$\$\$\$

[Explorez](#) [Créez votre porte](#)



GODEFROY



Couleur : **Blanc**

AUTHENTIQUE
Prix \$\$\$\$\$

[Explorez](#) [Créez votre porte](#)



LOTBINIÈRE



Couleur : **Blanc**

AUTHENTIQUE
Prix \$\$\$\$\$

[Explorez](#) [Créez votre porte](#)



GAREX

MODÈLES GAREX PORTES STANDARD+

PANORAMIQUE



Couleur : **Blanc**

MODERNE

Prix \$\$\$\$

[👁 Explorez](#) [✎ Créez votre porte](#)

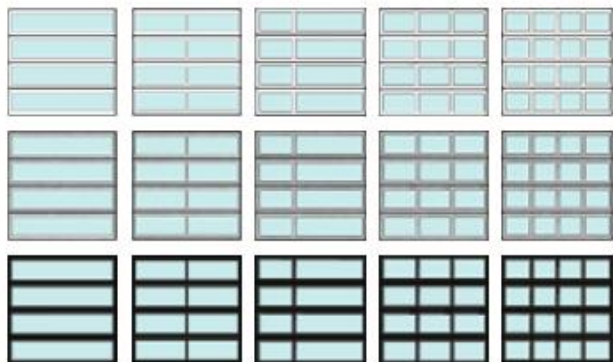

GARIX

Couleurs acier



BLANC



BLANC PUR (138)



KAKI



BRUN COMMERCIAL



SABLON



CHÊNE FONCÉ



CHARBON

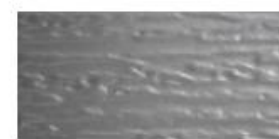

ARGENT



NOIR



MINERAI DE FER

Couleurs aluminium



BLANC



CLAIR



GRIS



BRONZE

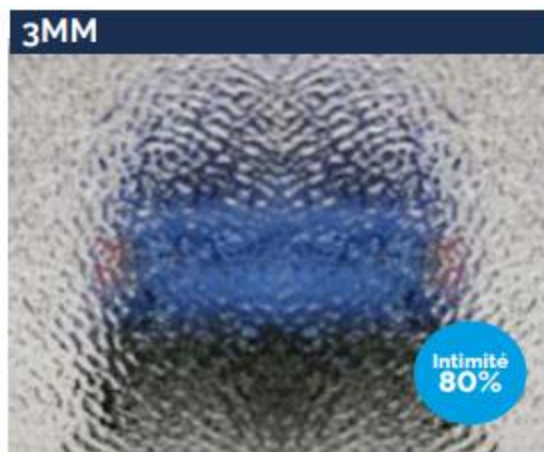

GIVRÉ / PIN HEAD



SATINÉ OPAQUE

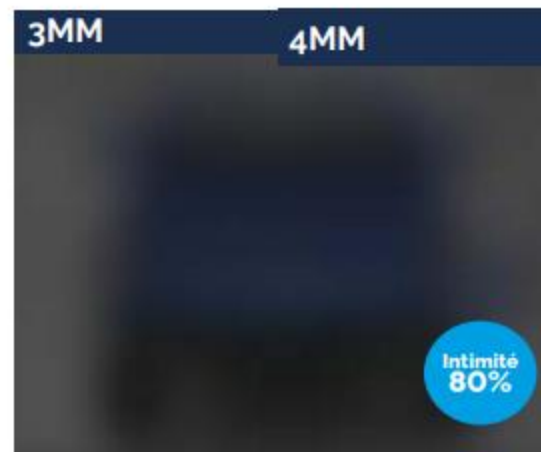

SATINÉ NOIR

NOUVEAU

NOUVEAU



TEINTÉ FONCÉE



GLUE CHIP



GRIS



MIRROPANE GRIS

*(Miroir transparent)



BRONZE



SUPERGRAY*

*(Disponible en verre trempé seulement)

Les photos présentées peuvent différer légèrement des teintes réelles des verres.
Plusieurs autres verres disponibles. Pour plus d'information, contactez votre distributeur Garex.

Porte commerciale de 24 po, disponible sur demande.
24" commercial door available upon request.



Les portes de garage commerciales et industrielles comprennent des portes rapides, des niveleurs de quai de chargement, des joints de quai et des abris, veuillez nous contacter pour un devis.

Commercial and industrial garage doors includes high speed doors, loading dock levelers, dock seals & shelters, please contact us for a quote.



CONTACT

6412 Trans Canada Route,
Saint-Laurent, Québec H4T 1X4
Phone: 514-800-1668
www.lifterqc.com



GARANTIE



WARRANTY



Installé et entretenu professionnellement par:
Professionally installed and maintained by:



Caractéristiques de Panneau

- Panneau de 2"
- Structure à triple couche
- Isolation R-18.4 sans CFC
- Acier galvanisé de 26 jauge
- Les joints intercalaires entre les sections
- 2" thick panel
- Triple-layer structure
- 18.4 R-value CFC-free insulation
- 26 gauge galvanized steel
- Tongue-and-groove joints

Panel Features

Options du Panneau



H110 - Panneau court surélevé
H110 - Raised short panel



H120 - Panneau long surélevé
H120 - Raised long panel



H140 - Panneau répoûssé H140 - Carriage panel

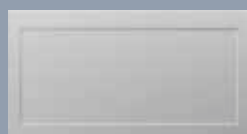

H150 - Panneau long encastré
H150 - Recessed Long Panel

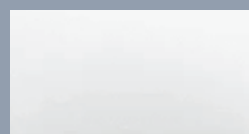

H180 - Panneau affleurant
H180 - Flush panel

Panel Options

Options de Couleur

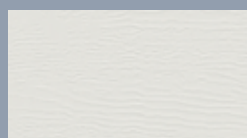

Blanc
White



Teinte sable
Sandstone



Gris Charbon Charcoal Gray



Marron foncé
Dark brown



Noir
Black

Color Options



HERITAGE 100



Caractéristiques de Panneau

- Panneau de 2"
- Structure à triple couche
- Isolation R-18.4 sans CFC
- Acier galvanisé de 26 jauge
- Les joints intercalaires entre les sections
- 2" thick panel
- Triple-layer structure
- 18.4 R-value CFC-free insulation
- 26 gauge galvanized steel
- Tongue-and-groove joints

Panel Features

Options du Panneau

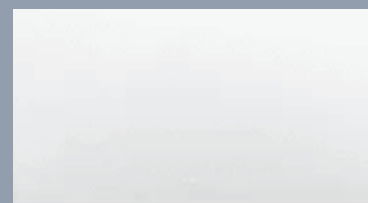

Panneau Affleurant
Flush Panel

Panel Options

Options de Couleur



Chêne Doré
Gold Oak



Planche Noyer
Walnut Plank



Planche Bois Gris
Graywood Plank



Planche Chêne
National Oak Plank

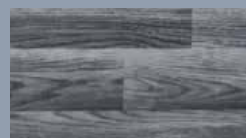

Noyer Foncé
Walnut

Color Options



ARTISAN 500



Caractéristiques de Panneau

- Panneau de 2"
- Structure à triple couche
- Isolation R-18.4 sans CFC
- Acier galvanisé de 26 jauge
- Les joints intercalaires entre les sections
- 2" thick panel
- Triple-layer structure
- 18.4 R-value CFC-free insulation
- 26 gauge galvanized steel
- Tongue-and-groove joints

Panel Features

Options du Panneau



Panneau Affleurant
Flush Panel

Panel Options

Options de Couleur

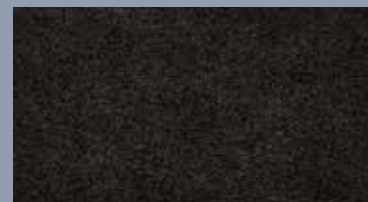

Noir Magnétite
Magnetite Black

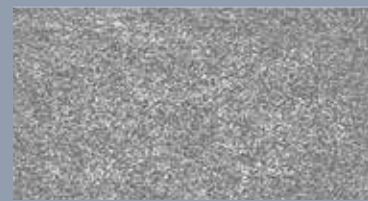

Gris Charbon Iron Ore Gray

Color Options



CONTEMPO 600

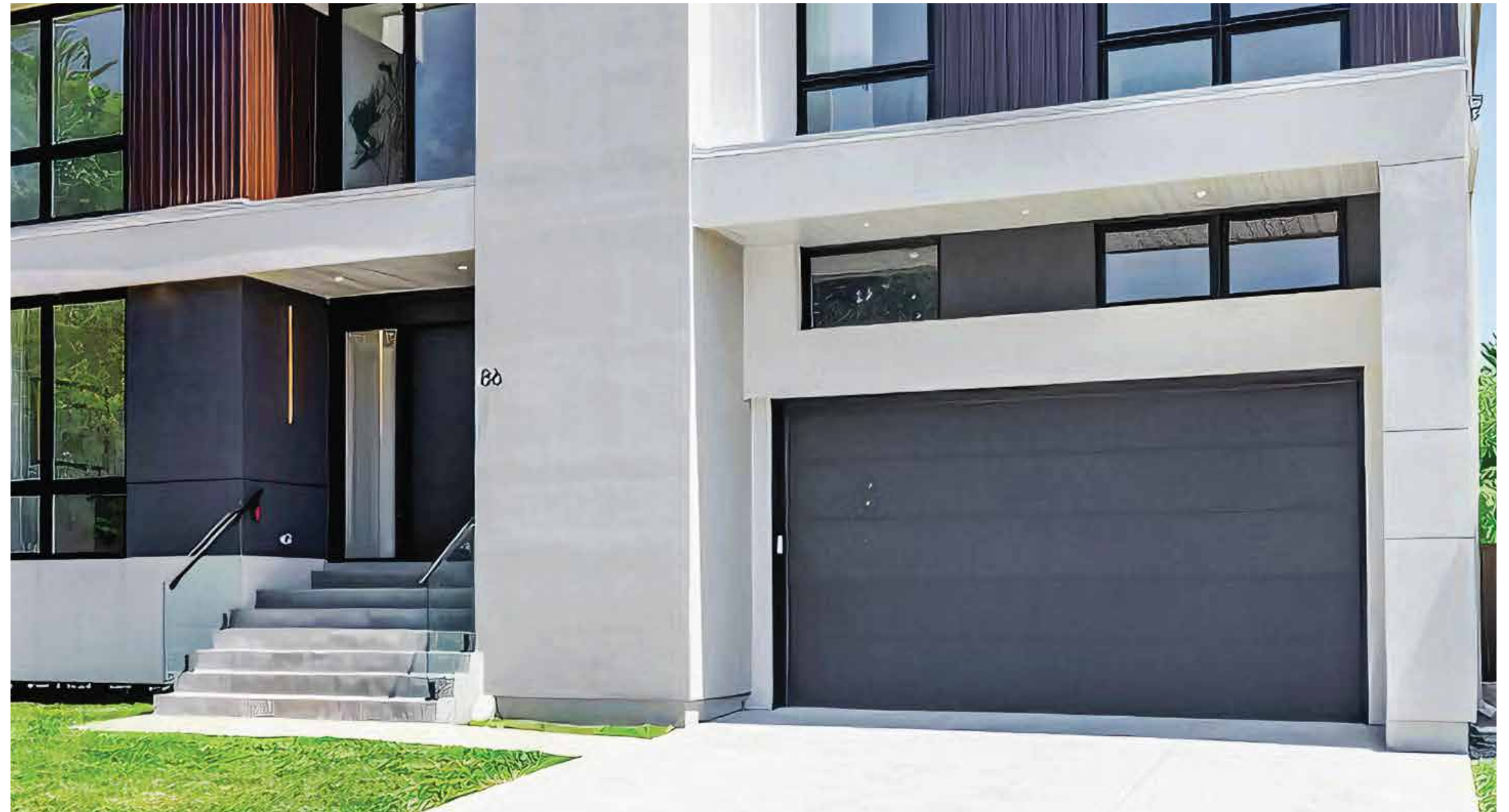

Caractéristiques de Panneau

- Panneau de 2"
 - Structure à triple couche
 - Isolation R-18.4 sans CFC
 - Acier galvanisé de 26 jauge
 - Les joints intercalaires entre les sections
- 2" thick panel
 - Triple-layer structure
 - 18.4 R-value CFC-free insulation
 - 26 gauge galvanized steel
 - Tongue-and-groove joints

Panel Features

Options du Panneau



Panneau Affleurant
Flush Panel

Panel Options

Options de Couleur



Gris
Gray



Noir
Black



Argent
Silver

Color Options



LUMELINE 900





Conception dissimulée

Panneaux de revêtement composites pour bois naturel et tons modernes, style minimaliste.



Concealed design

Composite siding panels for natural wood and modern tones, minimalist style.



Panneau en acier inoxydable avec style miroir

La surface réfléchissante ajoute non seulement une touche de sophistication, mais amplifie également la perception de l'espace, s'intégrant parfaitement aux designs architecturaux contemporains.



Stainless steel mirror-style

The reflective surface not only adds a touch of sophistication but also enhances the perception of space, seamlessly blending with contemporary architectural designs.



Conception panoramique

Le panneau en aluminium isolé de 2" offre un mélange parfait des espaces intérieurs et extérieurs, rehaussant l'attrait extérieur avec son design épuré et minimaliste.



Full view design

The 2" insulated aluminum panel offers a perfect blend of indoor and outdoor spaces, enhancing curb appeal with its sleek, minimalist design.



Porte-piéton intégré

Permet un accès piéton rapide sans ouvrir l'ensemble de la porte, pour gagner du temps, améliorer la sécurité/confidentialité, limiter les déperditions énergétiques et convenir aux usages quotidiens ou aux sous-sols.



Walk-through design

Features a built-in pedestrian door for quick access without opening the full door—saving time, boosting security/privacy, cutting energy loss, and perfect for frequent entry or basement setups.

Options de fenêtre

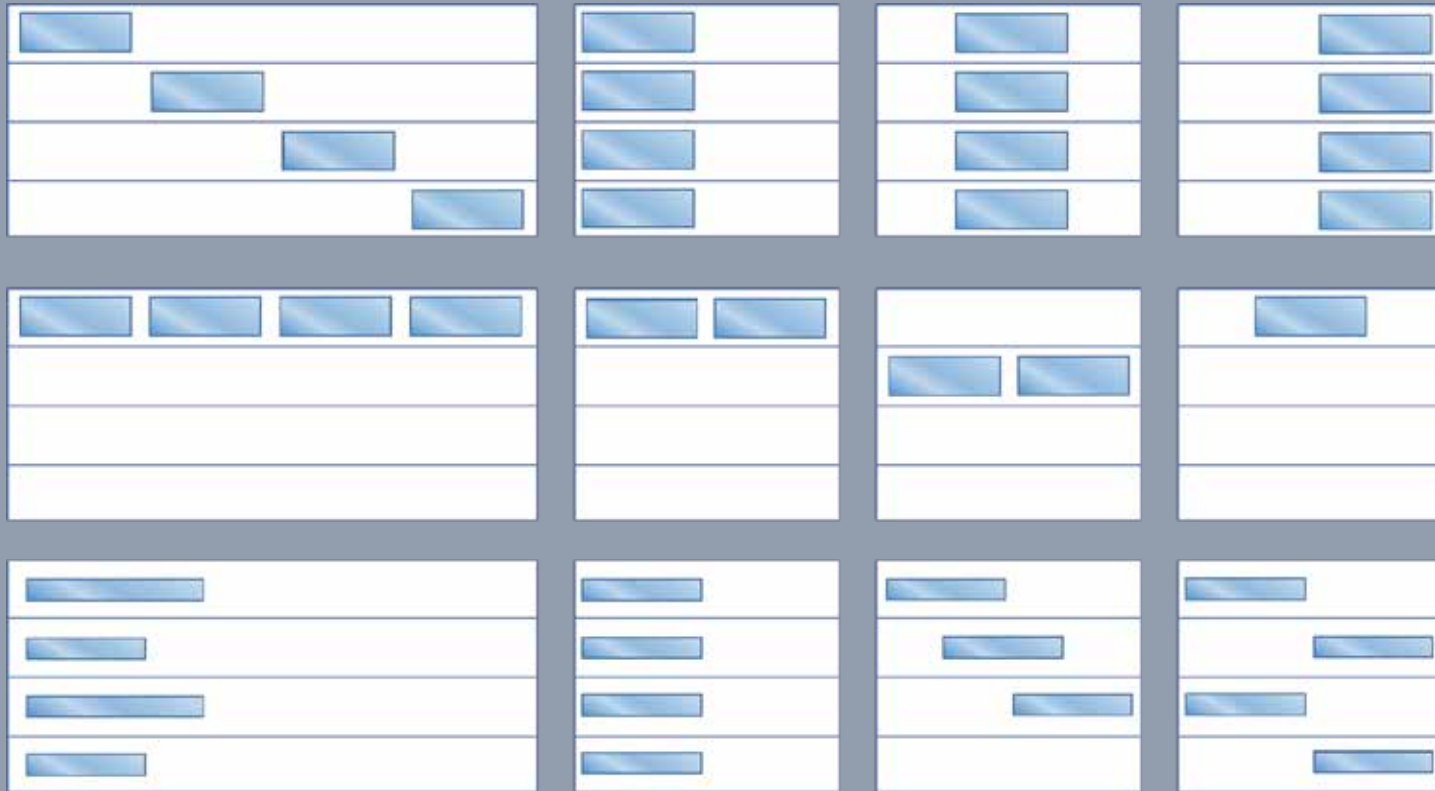

Window options

Options de verre



Clair (FR) Clear (EN)



Teinté (FR) Tinted (EN)

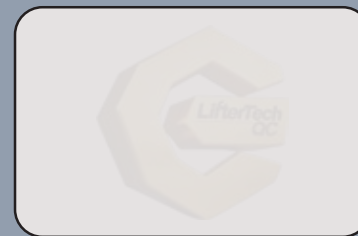

Givré (FR) Frosted (EN)

Glass options

Appliques décoratives



L002



L003



L004



L005

Accessoires



Decorative hardware

Quincaillerie haut de gamme

Quincaillerie avec revêtement en poudre

Comprend des charnières et des rails, il est résistant à la rouille et esthétiquement agréable, s'adaptant parfaitement au style de la porte de garage.



Powder-coated hardware

Including hinges and tracks, is rust-resistant and aesthetically pleasing, matching the style of the garage door seamlessly.

Rouleaux à roulement à billes robustes

Les rouleaux à roulement à billes en nylon haute performance contribuent à garantir un fonctionnement fluide et silencieux.



Heavy-duty ball bearing rollers

High performance nylon ball bearing rollers help ensure smooth, quiet operation.

Charnière silencieuse

Acier galvanisé de calibre 14, bagues en nylon autolubrifiantes, réduit le bruit et l'usure, deux fois plus résistant.



Quiet hinge

Galvanized 14-gauge steel, self-lubricating nylon bushings, reduces noise and wear, twice as strong.

Premium hardware

Ressort de revêtement électro-phorétique

La dernière technologie de revêtement par électrophorèse rend le remplacement des ressorts de porte de garage propre, longue durée d'utilisation et difficile à rouiller.



Electrophoretic coating spring

The latest Electroplating technology makes the Garage Door Springs Replacement clean, long usage, and not easy to rust.

Support de renfort d'ouvre-porte

Un renforcement approprié de la partie supérieure est nécessaire lors de la fixation d'un ouvre-porte de garage à votre porte de garage.



Opener reinforcement bracket

Proper top section reinforcement is required when attaching a garage door opener to your garage door.

Base anti-rouille pour chenilles

Le fond découpé de la chenille est sujet à la rouille et à la corrosion en contact direct avec le sol. Une base anti-rouille en ABS de haute qualité résout efficacement ce problème.



Track anti-rust base

The cut bottom of the track is prone to rust and corrosion when in direct contact with the ground. A high-quality ABS anti-rust base effectively addresses this issue.

Dispositif de sécurité Spring Break

Installé à l'extrémité du ressort de torsion, il se verrouille sur l'arbre de torsion en cas de rupture du ressort, empêchant ainsi la porte de tomber.



Spring break safety device

Installed at the end of the torsion spring. In the event of a spring break, it locks onto the torsion shaft, preventing the door from falling.

Dispositifs de sécurité contre la rupture de câble

Empêchent la chute des portes de garage en cas de rupture des câbles. Ils maintiennent la porte en place pour éviter les accidents.

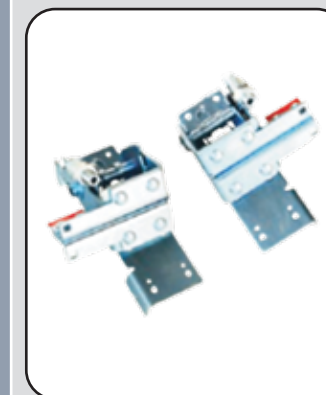

Cable break safety devices

Stop garage doors from falling if the cables snap. They keep the door secure to prevent accidents.

Peinture polyester (PE)
Époxy primaire
Revêtement de conversion chimique
Zinc
Substrat en acier

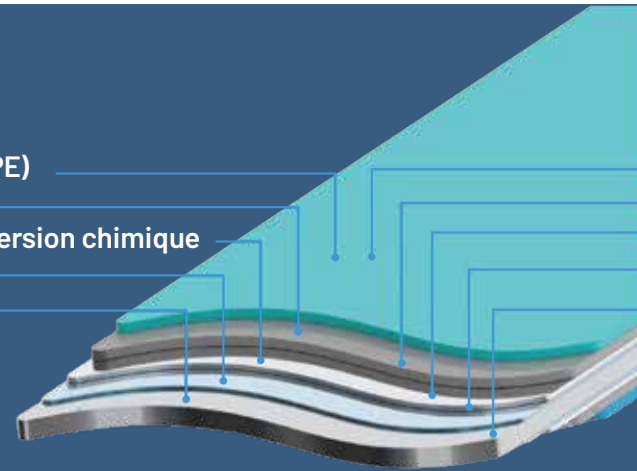

Polyester paint (PE)
Epoxy primer
Chemical conversion coating
Zinc
Steel substrate

Les portes LifterTech Québec possèdent une finition protectrice à double couches (polyuréthane et polyester durable) sur les surfaces intérieures et extérieures, assurant une excellente durabilité, une résistance à la corrosion et une esthétique soignée dans environnements divers.

LifterTech doors Quebec utilizes a multi-layer corrosion-resistant paint system, featuring a zinc-coated steel substrate, chemical conversion coating, epoxy primer, and a durable polyester on both sides for enhanced durability.

Joint d'étanchéité performants
Un pont thermique, avec une construction à rainure et languette et un joint en vinyle durable, évite le contact métallique et limite les transferts thermiques.

Isolation en polyuréthane
Assure une performance thermique avec un facteur U de 0,075 (valeur R de 18,4). Isolation en polyuréthane sans CFC.

Acier galvanisé de calibre 26
Revêtement anticorrosion à trois couches: apprêt polyuréthane et finition polyester durable, intérieur et extérieur.



Effective joint seals
A thermal break with tongue-and-groove construction and a sturdy vinyl seal, eliminating metal contact and reducing temperature transfer.

Polyurethane insulation
Provides thermal efficiency with 0.075 U-Factor (R-Value 18.4); CFC-Free polyurethane Insulation.

26-Gauge galvanized steel
Three-tier corrosion-resistant protective finish with a polyurethane primer and a durable polyester finish coat on the interior and exterior.

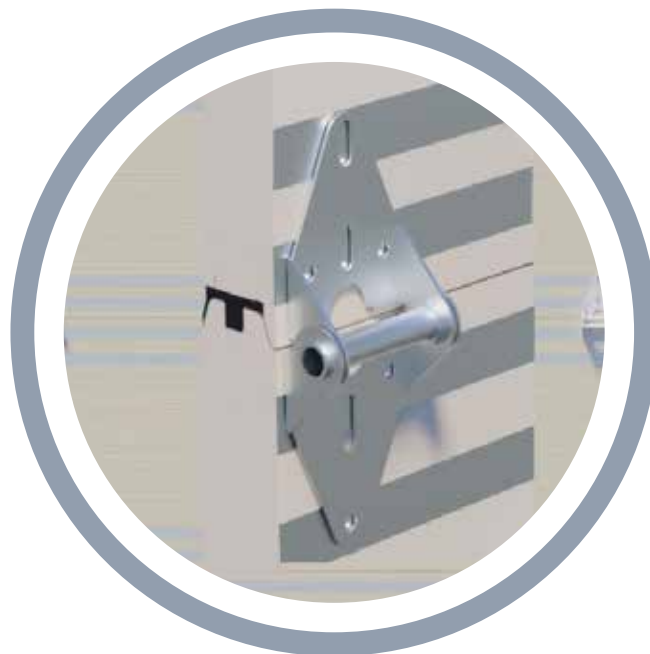
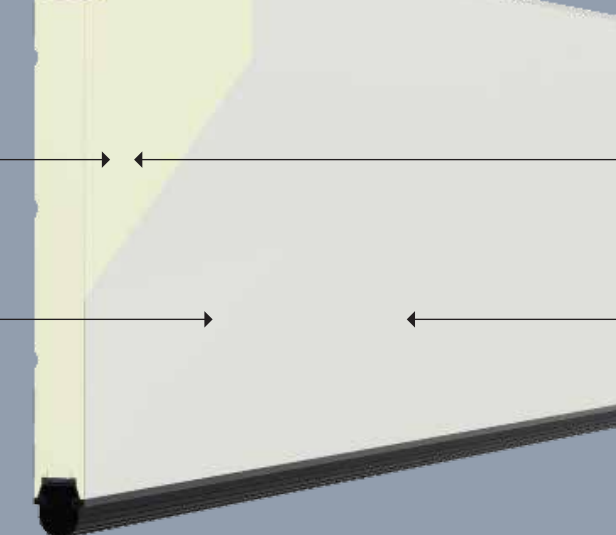

Système de renforcement par barres d'acier

- ▶ Support renforcé;
- ▶ Installation simplifiée;
- ▶ Durabilité améliorée.

Steel bar reinforcement system

- ▶ Enforced support;
- ▶ Simplified installation;
- ▶ Enhanced durability.

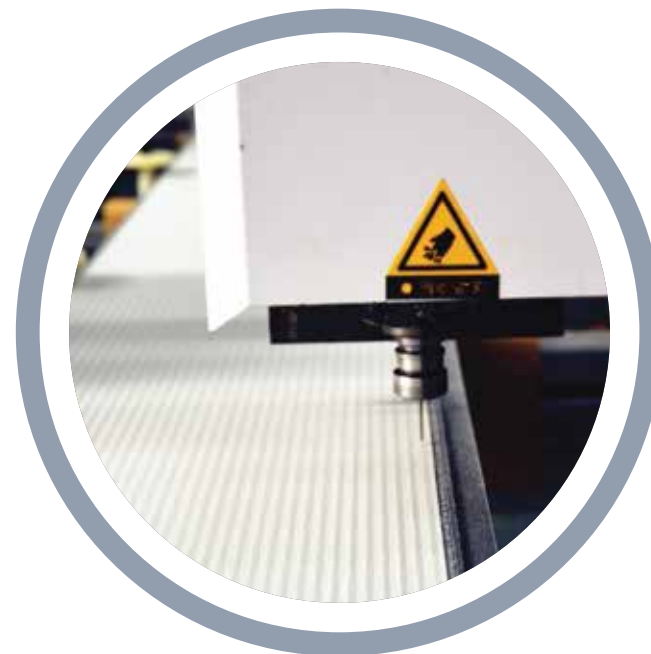

Technologie de pré-perçage de précision

- ▶ Installation plus facile et rapide;
- ▶ Précision de positionnement;
- ▶ Expérience valorisée.

Precision pre-drilling technology

- ▶ Easier installation and time-saving;
- ▶ Position accuracy;
- ▶ Improved experience.

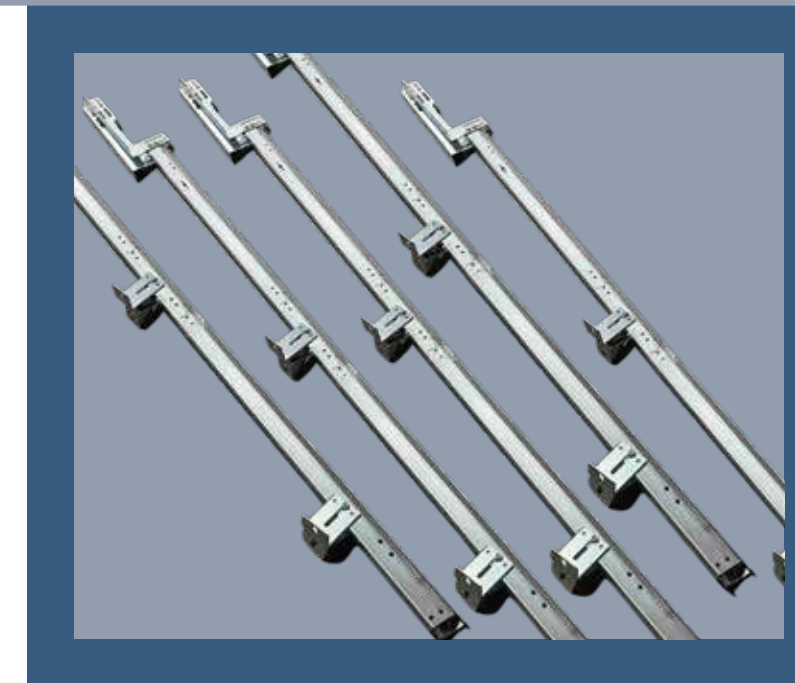

Rails pré-assemblés

- ▶ Installation plus facile et plus rapide;
- ▶ Éliminer les erreurs.

Pre-assembled rails

- ▶ Easier and faster installation;
- ▶ Eliminate errors.

Coupe-froid 2 en 1

- ▶ Élimine un assemblage de plus;
- ▶ Empêche le caoutchouc de se déformer et de rétrécir;
- ▶ Meilleure résistance aux intempéries.

2-in-1 weather stripping (vinyl and rubber together)

- ▶ No longer need to install the two pieces together;
- ▶ Preventing rubber deform and shrinking;
- ▶ Better weather resistance.

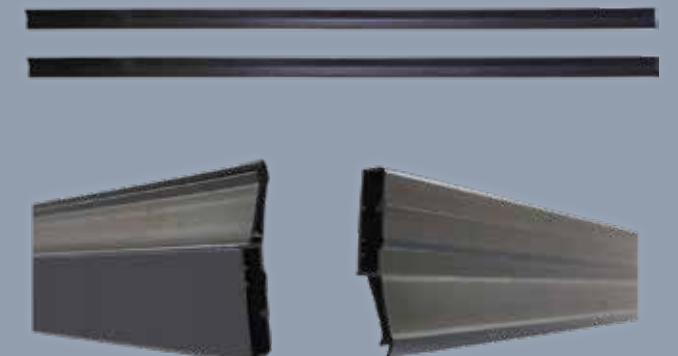



DDO8900W

Pour les portes à levage vertical, les portes sectionnelles commerciales à levage élevé et les portes de quai.

Ouverture vers le haut 50 % plus rapide
Wi-Fi® intégré

2220L

Ouvre-porte à entraînement à chaîne de 3/4 HP avec caméra intégrée et connectivité myQ



98022

Son design élégant et moderne libère de l'espace dans le garage. Fonctionnement rapide et silencieux, même pour les portes hautes et lourdes. Presque silencieux et sans vibrations. MyQ & wifi

6580L

Série Plus®
Silencieux et puissants, ces ouvre-portes comprennent également un éclairage à DEL lumineux et une commande par téléphone intelligent myQ.

